



Short description



- Good ability of anti-side loading
- Easy installation
- Stainless steel
- Can be used with Load Cell models: H8C, B8D, HM8C and BM8D

Available models

Model	Capacity	Full article description	Part number
BJ-8-220	0.5t – 2t	BJ-8-220-0.5t/2t	2080322

Specifications and dimensions are subject to change without notice and do not constitute any liability whatsoever.

Dimensions in mm

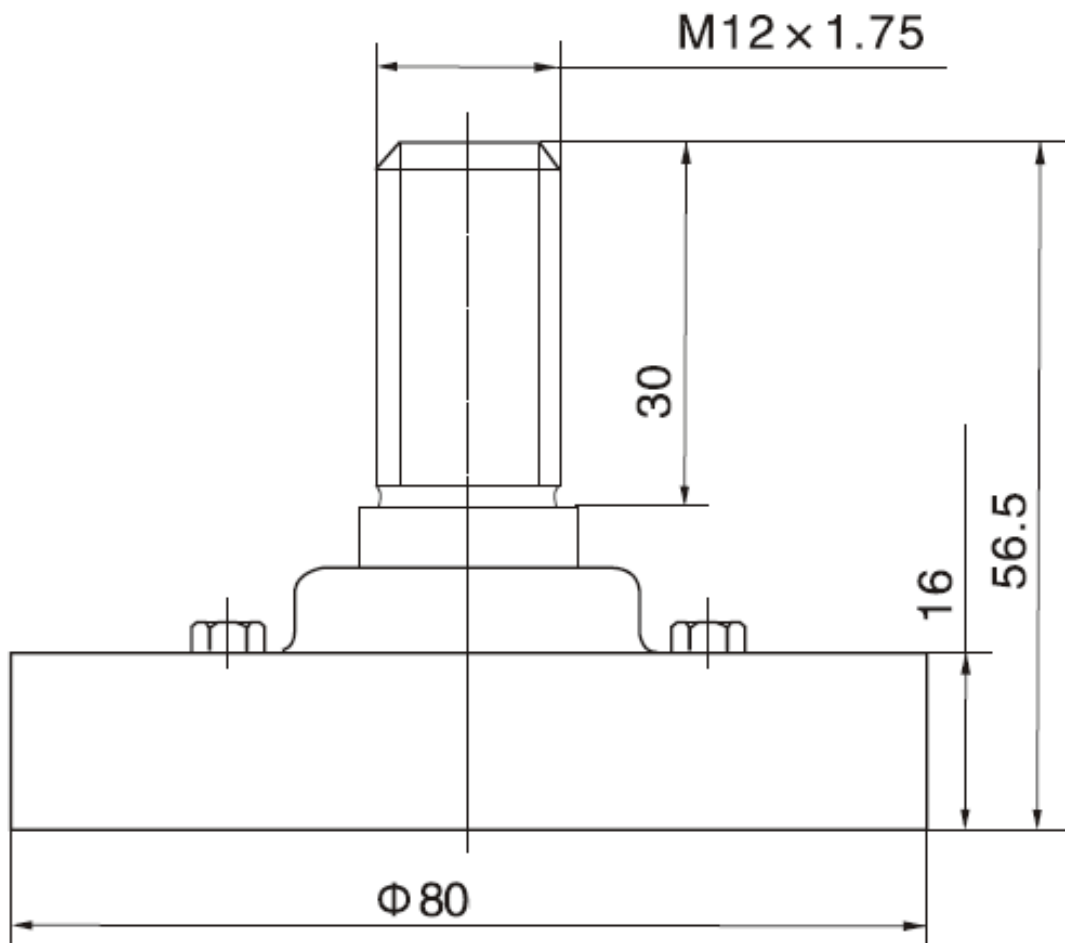

Specifications and dimensions are subject to change without notice and do not constitute any liability whatsoever.