

SPG

SPG SERIES SINGLE POINT LOAD CELLS, C3 CLASS



Load cells for off center loads, suitable for example to build CE-M approved scales with a single load cell; maximum platform dimensions of 600x600 mm.

CAPACITIES (kg): 10, 15, 20, 30, 50, 100, 200.

OIML R60. C3 precision class.

Aluminium alloy. **IP67** protection.

The best solution
for advanced industrial
applications

MAIN FEATURES

- C3 PRECISION CLASS
- OFF CENTER LOAD COMPENSATED
- ALUMINIUM ALLOY CONSTRUCTION
- IP67 PROTECTION
- MAX. CAPACITIES FROM 10 TO 200 kg
- FOR PLATFORMS WITH DIMENSIONS UP TO 600 X 600 mm
- SHIELDED CONNECTION CABLE
- OIML CERTIFICATE AVAILABLE UPON REQUEST
- TEST CERTIFICATE AVAILABLE UPON REQUEST

TECHNICAL FEATURES

- Minimum load cell verification interval:
 $V_{min} = E_{Max} / 10.000-15.000$
- Maximum number of verification intervals: $n_{LC} = 3000$
- Sensitivity: $2mV/V \pm 10\%$
- Temperature effect on zero:
from $\pm 0,0093\% F.S./10K$ to $\pm 0,0140\% F.S./10K$
- Temperature effect on Full Span:
 $0,011\% F.S./10K (-10^{\circ}C/+20^{\circ}C)$ $0,017\% F.S./10K (+20^{\circ}C/+40^{\circ}C)$
- Compensated Temperature Range: $-10^{\circ}C/+40^{\circ}C$
- Operating Temperature Range: $-10^{\circ}C/+50^{\circ}C$
- Maximum excitation voltage without damage: 15 Vdc
- Input Resistance: 300..500 Ohm
- Output Resistance: 300..500 Ohm
- Zero Balance: $0 \pm 0,12 mV/V$ (at 100 V)
- Insulation Resistance: $>2000 MOhm$
- Mechanical limit load in service: 150% F.S.
- Destructive load: 300% F.S.
- Deflection at nominal load $<0,5mm$
- 6-wire shielded cable, 3m long, 4,7mm diameter

ATEX Version

- The CCATEX certificate makes the load cell suitable for use in hazardous areas with protection methods according to:
ATEX II 1G Ex ia IIC T6 (Ta $-20^{\circ}C/+40^{\circ}C$) TX (Ta $-20^{\circ}C/+65^{\circ}C$) Ga
ATEX II 1D Ex ta IIIC TX $^{\circ}C$ (Ta $-20^{\circ}C/+40^{\circ}C$) TX $^{\circ}C$ (Ta $-20^{\circ}C/+65^{\circ}C$) Da IP65.
The certificate includes the manual and the ATEX CE conformity declaration (available in EN, DE, FR, and IT).
- **IMPORTANT:** the certificate refers to the single load cell. For systems with more load cells, it is necessary to order one certificate for each load cell.

DETAIL 1

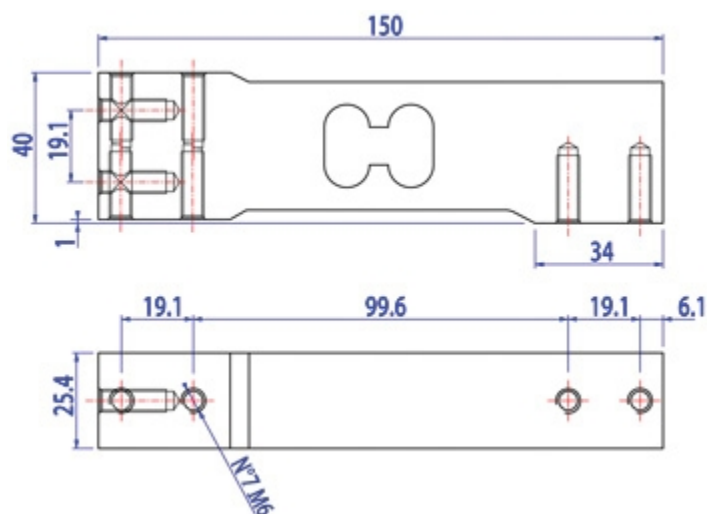







Dimensions (mm)

Wiring Code	
Colour	Function
YELLOW	SHIELD
WHITE	OUTPUT +
GREEN	SENSE +
BLUE	INPUT +
RED	OUTPUT -
GREY	SENSE -
BLACK	INPUT -

VERSIONS

Available versions

Codice	Piatto Max (mm)	Max (kg)
SPG10-1 	300x300	10
SPG15-1 	450x450	15
SPG20-1 	450x450	20
SPG30-1 	450x450	30
SPG50-1 	600x600	50
SPG100-1 	600x600	100
SPG200-1 	600x600	200



“YOUR WORLDWIDE PARTNER FOR WEIGHING”

DINI ARGEO
FRANCE sarl
France

DINI ARGEO
GMBH
Germany

DINI ARGEO
UK Ltd
United Kingdom

DINI ARGEO WEIGHING
INSTRUMENTS Ltd
China

DINI ARGEO
OCEANIA
Australia



COMPANY HEADQUARTERS

Via Della Fisica, 20
41042 Spezzano di Fiorano Modena • Italy
Tel. +39.0536 843418

SERVICE ASSISTANCE

Via Dell'Elettronica, 15
41042 Spezzano di Fiorano Modena • Italy
Tel. +39.0536 921784



SALES AND TECHNICAL ASSISTANCE SERVICE