

Short Description



- Nickel plated alloy steel load cell mount
- Adjustable mounting height
- Easy installation
- Using under heavy static load or slight dynamic load
- Can be used with load cell models: H8C, B8D* and BM8D*
- Mount delivered without a load cell. Load cell needs to be ordered separately

Available Models

Model	Capacity	Full Article Description	Part Number
HM-8-402	0.1 – 2t	HM-8-402-0.1t/2t	20830100
	2.5 – 5t	HM-8-402-2.5t/5t	20830200
	10t	HM-8-402-10t	20830290

Technical Specifications HM-8-402

Capacity with load cell	0.1t – 2t	2.5t – 5t	10t
Maximum vertical force (down)	10 kN	15 kN	30 kN
Maximum vertical force (up)	5 kN	7 kN	20 kN
Maximum horizontal force	3 kN	5 kN	10 kN
Maximum horizontal movement	± 2.0 mm	± 2.5 mm	± 3.5 mm

* = B8D & BM8D only up to 2t.

Specifications and dimensions are subject to change without notice and do not constitute any liability whatsoever.

Type HM-8-402 Mount

Dimensions in mm

Side View

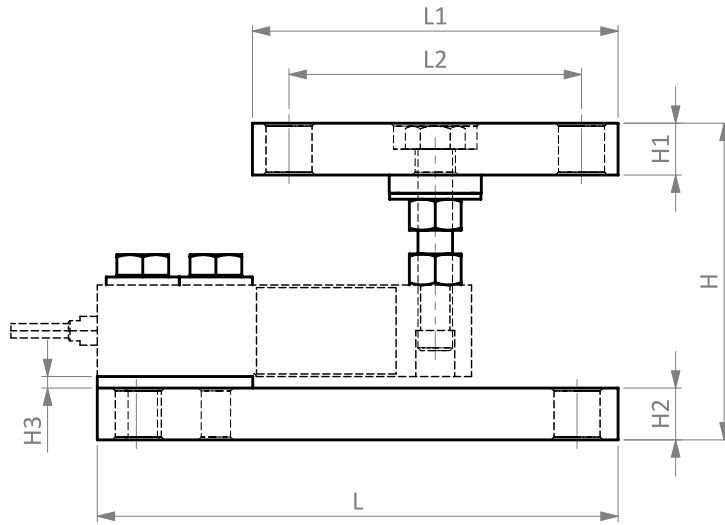

Front View

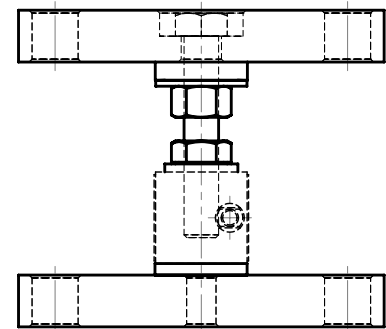

Top View

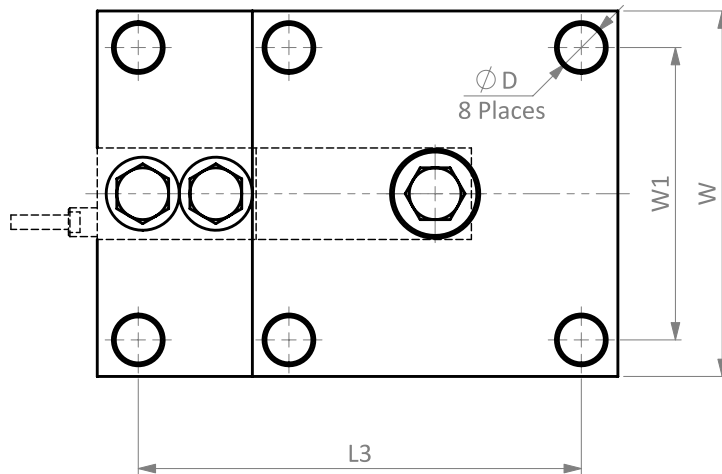

Isometric View

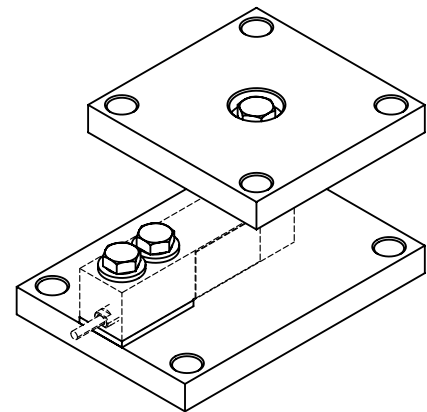

Dimension Capacity	L	L1	L2	L3	H	H1	H2	H3	W	W1	ØD
0.1t – 2t	180.9	127	101.6	152.4	100-120	18	18	4	127	101.6	16
2.5t – 5t	215.9	127	101.6	177.8	130-150	26	26	4	127	101.6	16
10t	285.8	177.8	127	235	195-215	38	38	6.1	177.8	127	21

Specifications and dimensions are subject to change without notice and do not constitute any liability whatsoever.